

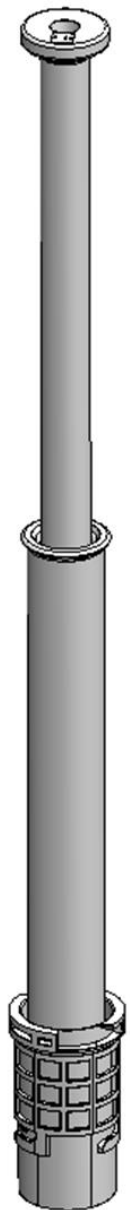

B L U E S Q U A R E[®]

Q360 Telescoping Bubbler Installation and Maintenance Guide

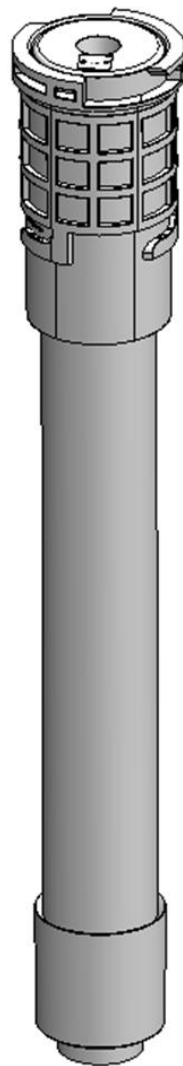

Contents

IMPORTANT WARNINGS AND SAFETY INSTRUCTIONS

- Introduction
- Installation
 - Plumbing Instructions
 - Plumbing Detail
 - Gunite Detail
 - Startup Instructions
- Maintenance

IMPORTANT SAFETY INFORMATION

When installing and using this equipment, basic safety precautions should always be followed.

****READ AND FOLLOW ALL INSTRUCTIONS****

WARNING

To reduce risk of injury, do not permit children to use this product unless they are closely supervised at all times.

WARNING

Swimming Pool equipment can generate high pressures capable of causing injury. Always use caution when manipulating valves associated with the pool equipment and turn off the pump if pressures exceed manufacturer's specification. Always turn off the pool equipment when disassembling or servicing your circulation system.

WARNING

Swimming Pool equipment can create suction sufficient to entrap even adults. If pool fittings are broken or missing, turn off your equipment and contact a certified swimming pool expert to make the needed repairs.

Components

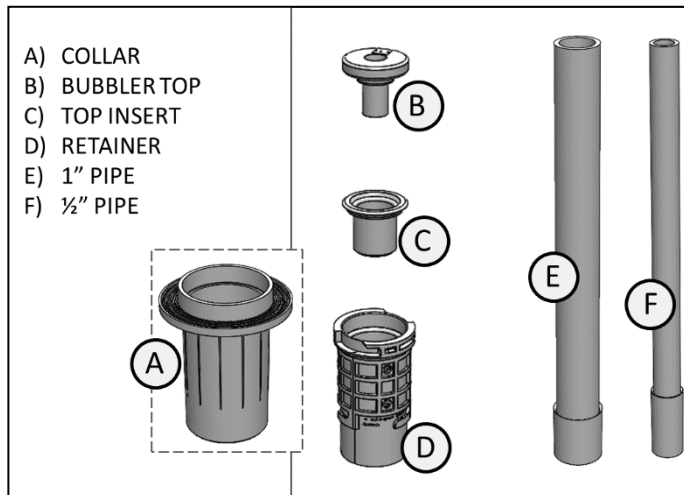

SAVE THESE INSTRUCTIONS

For customer service or support:

For on-line support: www.bluesquaremfg.com

To contact Blue Square: (800) 277-4150

INTRODUCTION

The Q360 Telescoping Bubbler is designed to add additional beauty to any pool or spa. When the bubbler is extended, the bubbling effect and tranquil sound of falling water can instantly relax and rejuvenate you, adding a sense of peace and tranquility to your outdoor pool environment.

When retracted, the bubbler sits flush with your pool or spa floor, steps, benches, or sun decks making it virtually undetectable. Two color options, grey and white, are available to further help match your pool finish and make the Q360 Telescoping Bubbler nearly invisible.

NOTE

Failure to follow recommended installation methods could void warranties and cause injury.

Installation

Plumbing Instructions

1. Choose the Location – The maximum water depth that the bubbler can be installed is 36 inches. The minimum water depth that the bubbler can be installed is 6 inches. In order to minimize water splashing outside the body of water, the bubbler can be plumbed no closer than 6 inches from the front edge of a step or shelf area or 8 inches from the back or side of the wall. (Fig. 1)
2. Dig trenches for 2" Sch. 40 plumbing to the location of the Fountain. Plumb into the bottom of the bubbler using sweep 90° elbows and connects into a vertical riser.
3. The top of the riser should extend beyond the top of the finished gunite level by at least 6-8 inches. Glue a cap on top of the riser that will remain in place until after pressure testing is complete and the gunite has been applied and cured.
4. Pressure-test the bubbler housing in accordance with local codes (pressure to remain on system until plaster).
5. Backfill the plumbing trenches with dirt to maintain its vertical alignment. Pack dirt around the bottom end of the riser to hold it plumb and stabilize it.

NOTE

If the Fountain Housing is not plumbed vertically, it will not retract properly

CAUTION

Ensure piping is adequately supported on undisturbed earth. Do not stress pipe by lifting or moving pipe after the connections have been made.

6. The depth of the pipe should be calculated by using $1/2WD+4"$ (Fig. 1) This will guarantee the bubbler can fully retract and sit flush with the pebble finish. After the completion of gunite application, use a reciprocating saw to cut the riser flush with the level of the finished gunite. After the riser has been cut flush, remove any burrs off the edges of the cut surface with a PVC reamer.

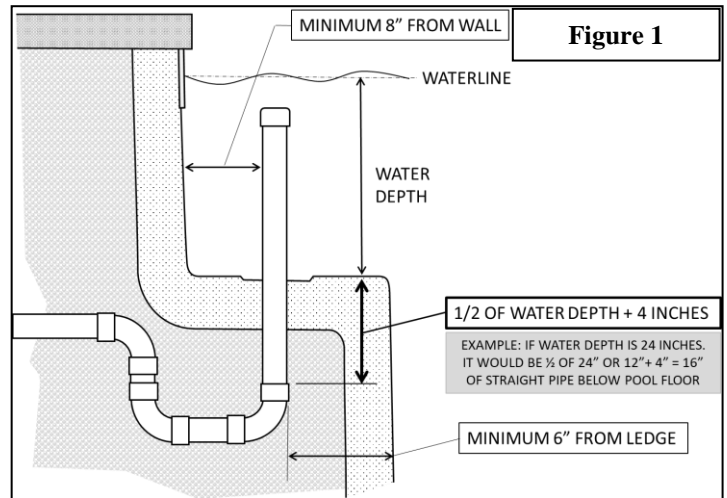

NOTE

Left attached, burrs can compromise the effectiveness of the seal.

7. Before installing the collar, first dry fit it in the riser in order to insure the proper fit inside of the riser and ream the pipe if necessary. Install the provided Blue Square collar by first applying primer, and then a liberal amount of clear medium/heavy bodied PVC glue and sliding the collar smoothly into the riser.
8. The chosen pool finish should be applied flush with the top of the collar. Ensure the protective orange cap is in place during this step to prevent pool finish from getting into the collar and possibly causing problems with bubbler installation, extension, and retraction. (Fig. 2)
9. Finally, the telescoping bubbler itself is ready to be installed.

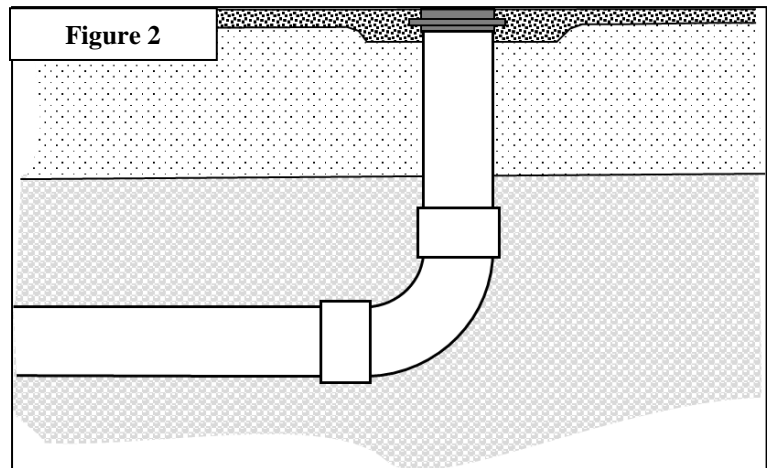

Plumbing Detail

Telescoping Bubbler Manifold Plumbing with a Q360 Infloor Cleaning System (Fig.3)

1. The Telescoping Bubbler should not be plumbed in line with the infloor cleaning system as it will rob flow from the cleaning system and cause less than optimal performance. An optional plumbing schematic is provided in Figure 3.
2. Each telescoping bubbler should be run with its own 2" gate valve to allow adjustment of water to achieve the desired bubbler effect.

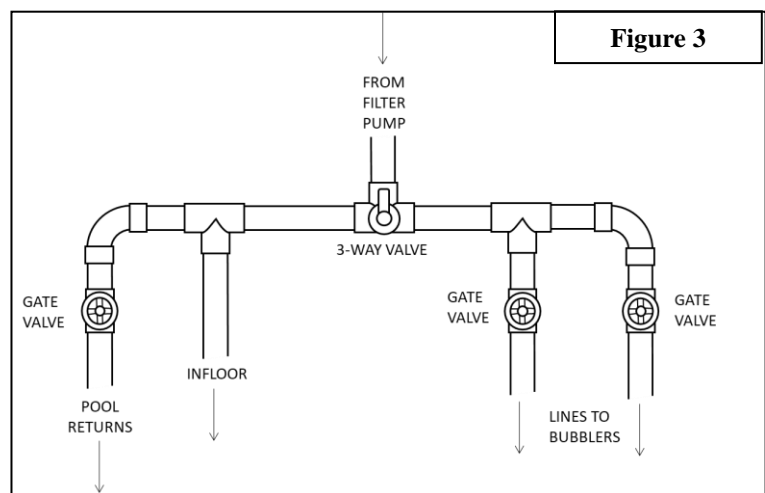
**NOTE**

Blue Square does not recommend using PVC ball valve in place of the gate valve to the bubblers due to the inability to make minor flow adjustments which create the desired bubble effect.

- It is recommended that a 2-way or 3-way valve be plumbed between the last Tee fitting telescoping bubbler and any additional features (pool wall returns, water features, spa returns, etc) so the bubbler water heights may be adjusted individually.

Telescoping Bubbler Manifold Plumbing without a Q360 Infloor Cleaning System (Fig. 4)

- Each bubbler should have its own Tee fitting and out of the T fitting, each telescoping bubbler should be run with its own 2" gate valve to allow adjustment of water to achieve the desired bubbler effect.
- It is recommended that a 2-way valve be plumbed between the last Tee fitting telescoping bubbler and any additional features (pool wall returns, water features, spa returns, etc) so the bubbler water heights may be adjusted individually.

NOTE

Blue Square does not recommend using PVC ball valve in place of the gate valve to the bubblers due to the inability to make minor flow adjustments which create the desired bubble effect.

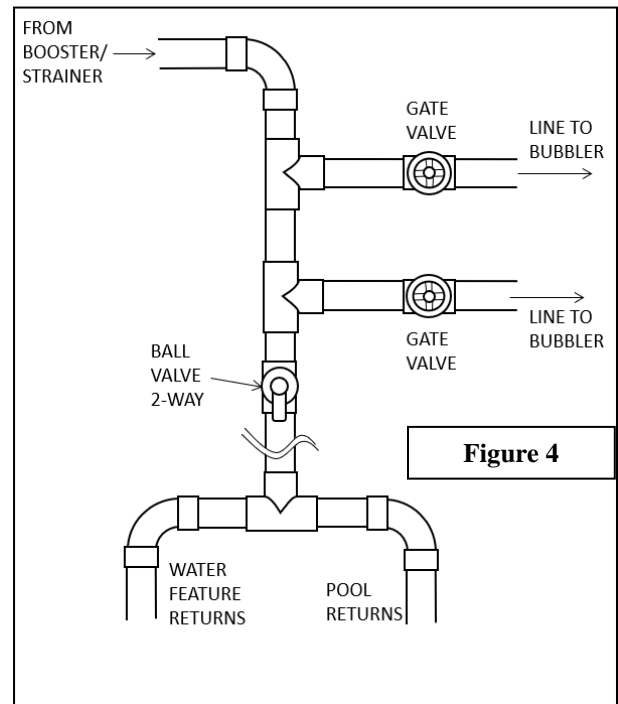

Figure 4

Gunite Detail

- After the gunite has been applied and pressure tests have been completed, utilize a reciprocating saw to cut off the riser pipe flush with the gunite surface. (Fig. 5)
- After the riser has been cut flush, remove any burrs off the edges of the cut surface with a standard PVC reamer. Dry fit the collar into the pipe riser. (Fig. 6)
- Apply PVC primer to both the collar and the inside of the PVC pipe. Apply medium body PVC glue to both the collar and the inside of the PVC Pipe. Push the collar into the pipe until the bottom of the water stop on the collar bottoms out on the top of the pipe.
- The finished product should look like Figure 7. As shown, leave the orange plaster cap in place during plaster application.



Figure 5



Figure 6

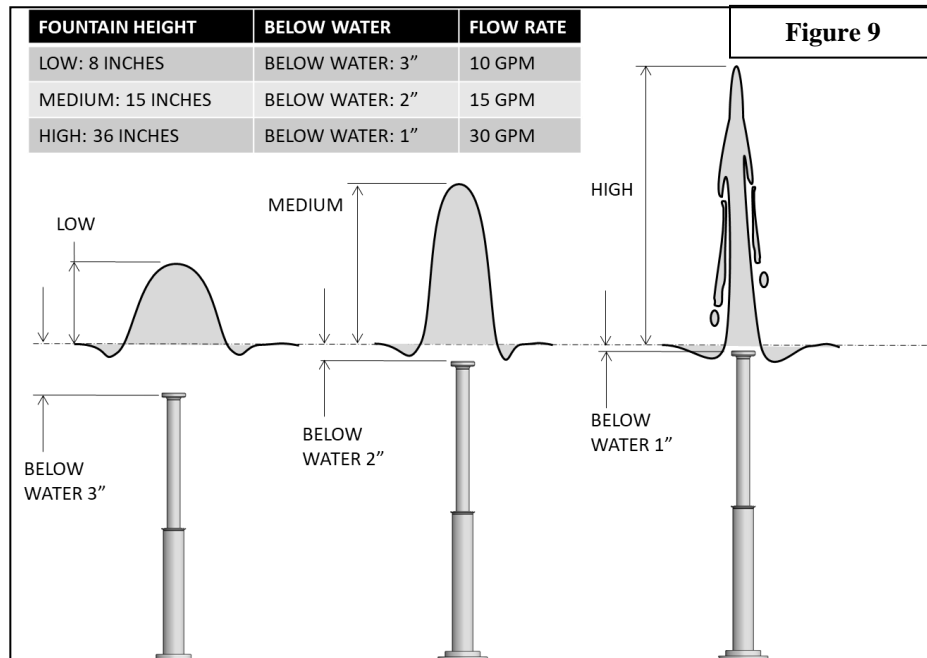

Figure 7

Startup

Instructions

1. Remove the orange plaster cap from the collar and blow out the lines to remove any construction debris that may be in the pipes.
2. Utilize Figure 9 to determine the desired bubbler effect.



3. After determining the desired height of the bubbler as well as the preferred depth below the water line by using the calculations in figure 10.
4. Dry fit the Q360 Telescoping Bubbler together and measure from the top of the sleeve to the top of the cap. Determine total the total length that needs to be removed from both the 1/2" pipe and the 1" pipe.

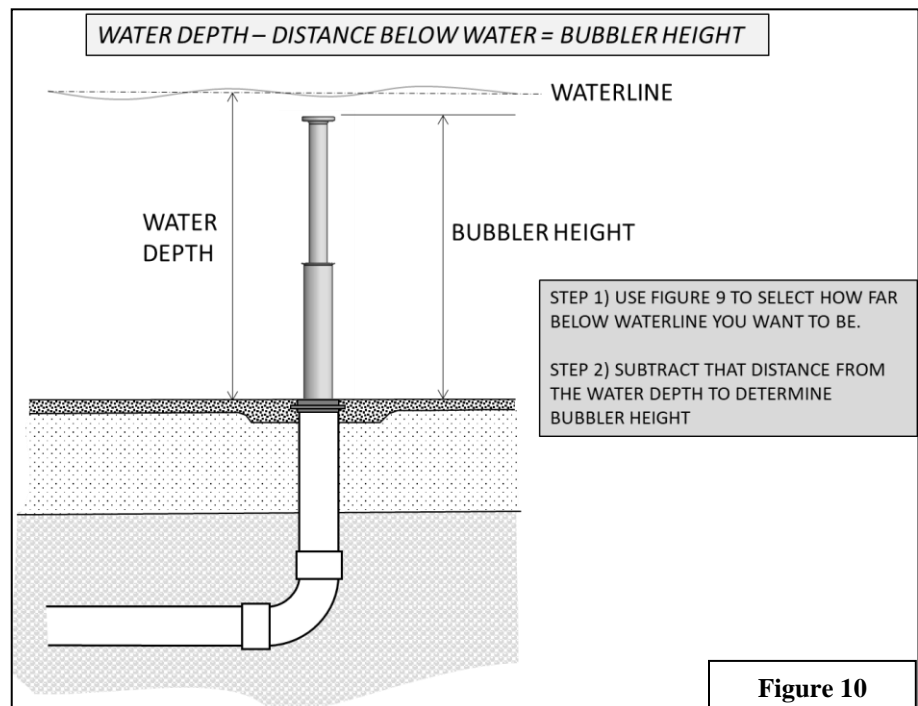

NOTE

Blue Square recommends cutting equal amounts of material from the 1" pipe and the 1/2" pipe so the bubbler telescopes and retracts properly.

5. Utilizing PVC pipe cutters, cut the unneeded material from both lengths of pipe. (Fig. 11)

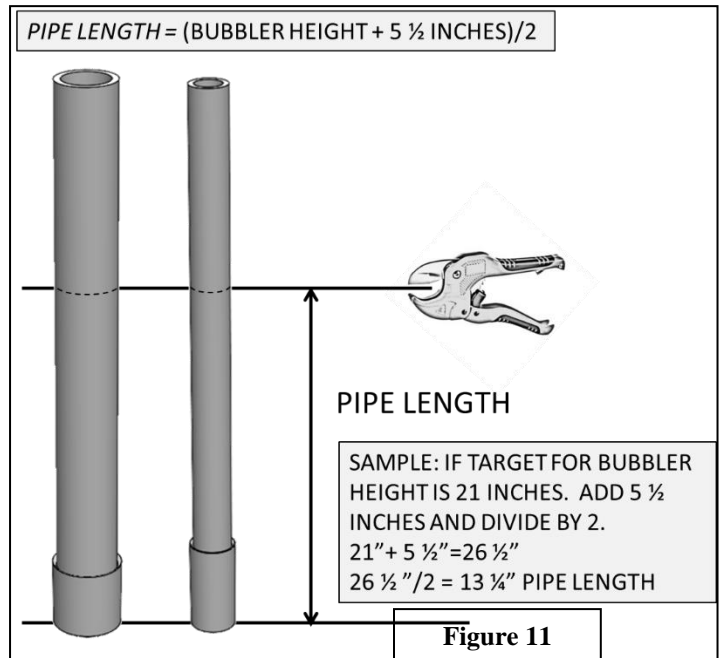
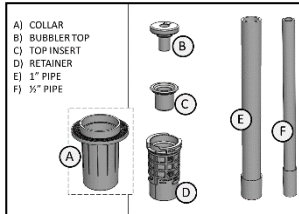

6. Slide the retainer (D) over the 1" pipe (E).
7. Utilizing primer and medium body clear PVC glue, glue the Top Insert (C) to the top of the 1" pipe (E).

NOTE

Please allow adequate cure time in between component assembly in accordance with PVC glue manufacturer guidelines.

8. Slide the 1/2" pipe (F) up through the bottom of the 1" pipe (E) until the top of the pipe is visible.
9. Glue the ½" bubbler top (B) on the 0.5" pipe (F) utilizing primer and medium body clear PVC glue. (Fig. 12)

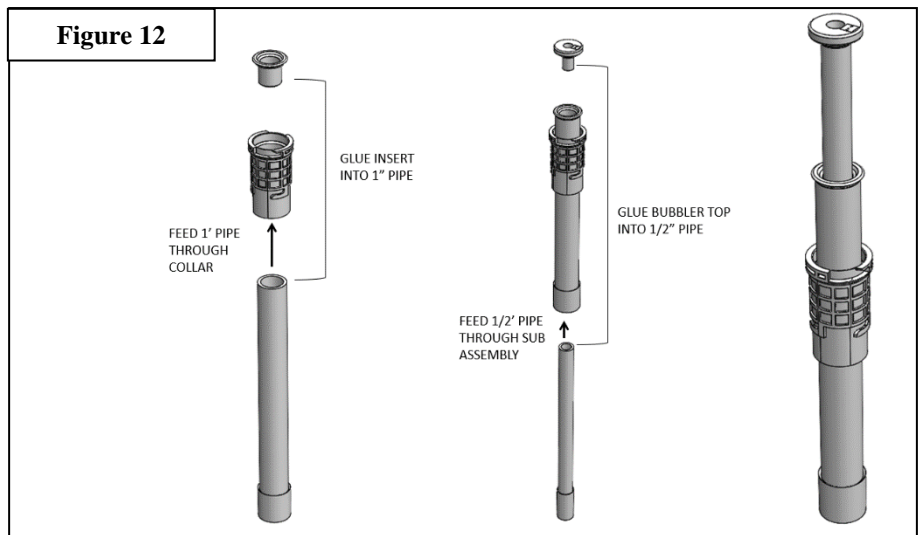

CAUTION

Please allow adequate cure time in accordance with the PVC glue manufacturer guidelines before utilizing the telescoping bubbler in water.

WARNING

PVC GLUE AND PRIMERS CAN BE FLAMMABLE, POISONOUS OR BOTH. CLOSELY FOLLOW MANUFACTURER'S INSTRUCTIONS. MAINTENANCE

Bubbler: Periodically check the bubbler top to ensure debris is not impeding nozzle flow.

NOTES

Blue Square Manufacturing, LLC
3344 N. Nevada St.
Chandler, AZ 85225
Office 480.612.6880 Toll Free 800.277.4150
sales@bluesquaremfg.com